

Specifications

For other materials or modifications, please consult TESCOM.

OPERATING PARAMETERS

Pressure rating per criteria of ANSI/ASME B31.3

Maximum Inlet Pressure

120, 600, or 3500 psig / 8.3, 41.4, or 241 bar

Outlet Pressure Ranges

50 mm Hg absolute - 15 psig / 1.0 bar

50 mm Hg absolute - 30 psig / 2.1 bar

50 mm Hg absolute - 60 psig / 4.1 bar

50 mm Hg absolute - 100 psig / 6.9 bar

Design Proof Pressure

150% of maximum rated

Inboard Leak Rate

$<1 \times 10^{-9}$ atm cc/sec He

Operating Temperature

PCTFE Seat: -40°F to 140°F / -40°C to 60°C

Teflon® Seat: -40°F to 160°F / -40°C to 71°C

Flow Capacity

$C_v = 0.24$ (120 psig / 8.3 bar model)

$C_v = 0.15$ (600 psig / 41.4 bar model)

$C_v = 0.06$ (3500 psig / 241 bar model)

MEDIA CONTACT MATERIALS

Body

316L Stainless Steel Electropolish or

316L VAR Stainless Steel Electropolish

Valve Seat

Teflon® or PCTFE

Diaphragm

316L Stainless Steel

Valve Stem, Spring, and Valve Guide

316 Stainless Steel

OTHER

Internal Surface Finish

10 R_a microinch / 0.25 micrometer

Connections

Welded female or male VCR®

Tube stubs

High Purity Internal Connections (H.P.I.C.)

(Internal style of VCR®, compatible with male swivel VCR®)

Cleaning

DI water electronic grade cleaned and ES 500 Particle Certified for internal electropolish models

Internal Volume

2.9 cc

Weight

2.0 lbs / 0.9 kg

Teflon® is a registered trademark of E.I. du Pont de Nemours and Company.

Hastelloy® is a registered trademark of Haynes International, Inc.

VCR® is a registered trademark of Cajon Co.



TESCOM 64-5000 Series ultra high purity, absolute/subatmospheric pressure reducing regulator offers a 10 R_a surface finish. Inlet pressures are 120, 600, or 3500 psig / 8.3, 41.4, or 241 bar with outlet pressures ranges from 50 mm Hg absolute - 15 to 100 psig / 50 mm Hg absolute - 1.0 to 6.9 bar.

Applications

- Vacuum pressure control
- Toxic gas analysis
- Valve manifold boxes
- Gas cabinets
- Semiconductor manufacturing

Features and Benefits

- Negative bias for controlling vacuum and low positive pressures
- 10 R_a microinch / 0.25 micrometer internal surface finish
- Metal-to-metal diaphragm to body seal for high leak integrity
- Hastelloy® trim option is available

64-5000 Series Regulator Drawing

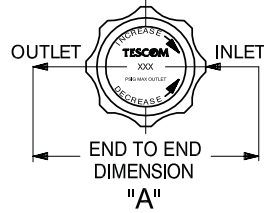
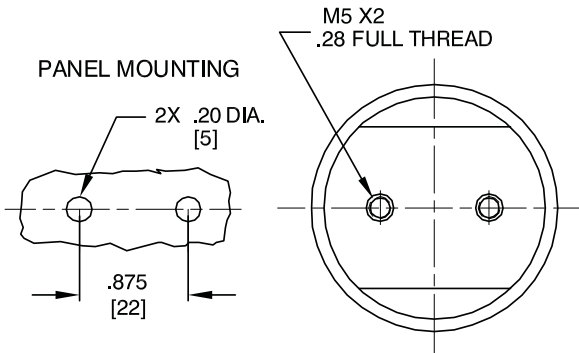
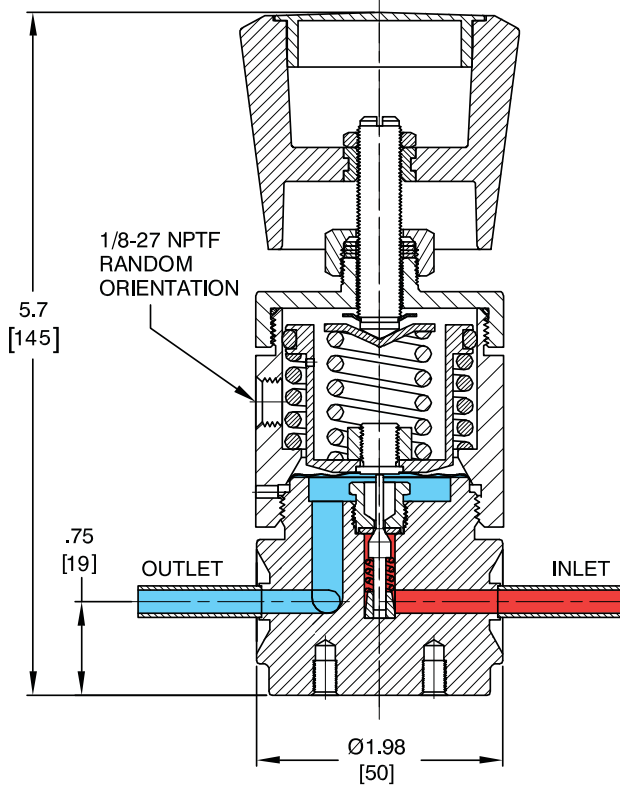

Figure A
(no gauges)

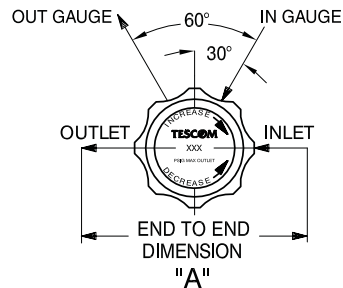

Figure B
(2 gauges)

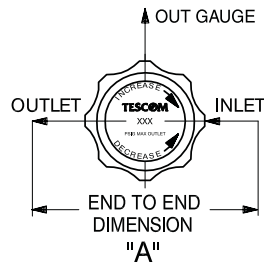

Figure C
(1 gauge)

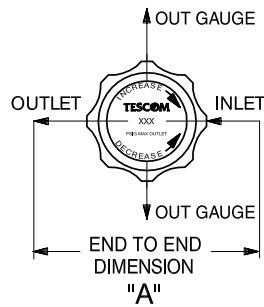
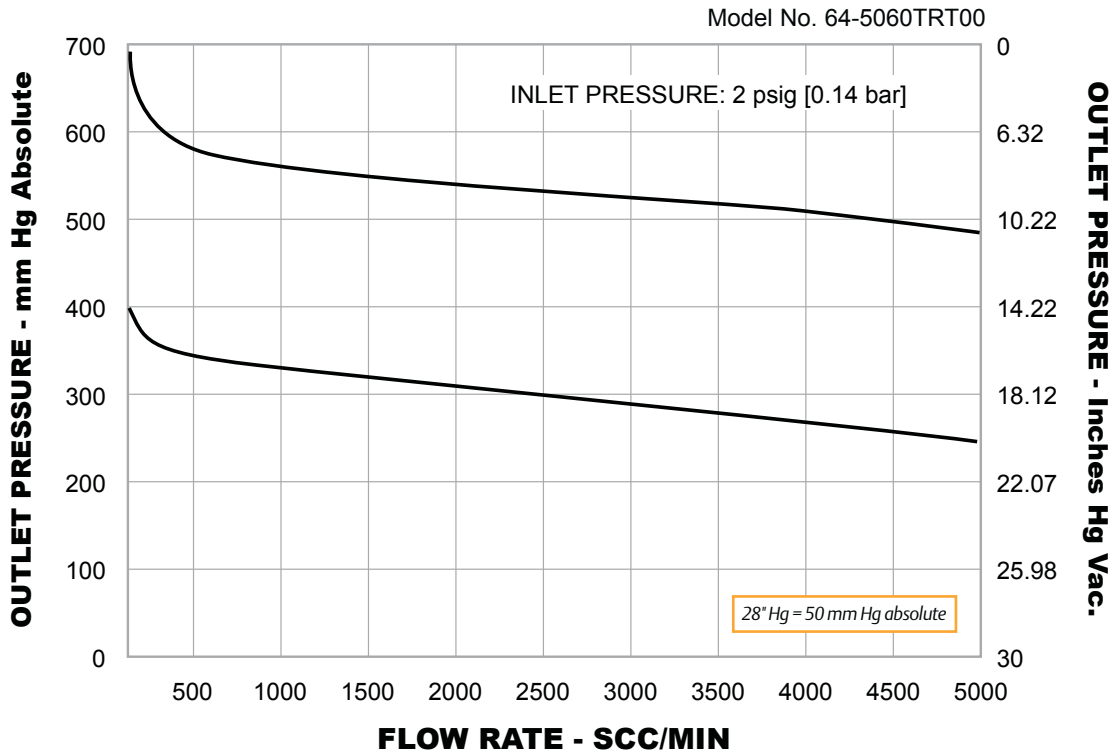

Figure D
(2 out gauges)

All dimensions are reference & nominal
Metric [millimeter] equivalents are in brackets

64-5000 Series Regulator Flow Chart

For more information on how to read flow curves, please refer to the Flow Curves and Calculations document (debul2007x012) in the TESCOM catalog or on www.tescom.com.



64-5000 Series Regulator Part Number Selector

Repair Kits, Accessories & Modifications may be available for this product. Please contact TESCOM for more information.

Example for selecting a part number:

64-50	6	0	T	A4	1	0		
BASIC SERIES	BODY MATERIAL	OUTLET PRESSURE RANGES ³	SEAT MATERIAL	INLET AND OUTLET PORT SIZE AND TYPE	'A' ± .06"	MAXIMUM INLET PRESSURE C _v	GAUGE PORT OPTION	NO. OF GAUGE PORTS (FIGURE)
64-50	4 – 316L Stainless Steel Electropolish: 10 R _a ¹ 6 – 316L VAR Stainless Steel Electropolish: 10 R _a ²	0 – 50 mm Hg absolute - 15 psig / 1.0 bar 1 – 50 mm Hg absolute - 30 psig / 2.1 bar 2 – 50 mm Hg absolute - 60 psig / 4.1 bar 3 – 50 mm Hg absolute - 100 psig / 6.9 bar	K – PCTFE V – Teflon®	A4 – 1/4" H.P.I.C.	–	0 – 120 psig 8.3 bar C _v = 0.24	0 – None	0 (Figure A)
				RK – 1/2" Male Swivel	4.75"		1 – 1/4" H.P.I.C.	1 (Figure C)
				RL – 1/2" Female Swivel	4.75"		2 – 1/4" H.P.I.C.	2 (Figure B)
				RM – 1/4" Male Swivel	3.70"		3 – 1/4" H.P.I.C.	2 (Figure D)
				RT – 1/4" Female Swivel	3.70"		4 – 1/4" Male Swivel	2 (Figure D)
				RU – IN Port: 1/4" Male; OUT Port: 1/4" Female	3.70"		5 – 1/4" Male Swivel	1 (Figure C)
	RV – IN Port: 1/4" Female; OUT Port: 1/4" Male T4 – 1/4" Tube Stubs	3.70"		6 – 1/4" Male Swivel	2 (Figure B)			
		3.70"		7 – 1/4" Female Swivel	2 (Figure D)			
		3.70"		8 – 1/4" Female Swivel	1 (Figure C)			
		3.70"		9 – 1/4" Female Swivel	2 (Figure B)			
		3.00"		S – 1/4" Fixed Male	2 (Figure B)			
		3.00"		T – 1/4" Fixed Male	1 (Figure C)			
		3.00"		U – 1/4" Fixed Male	2 (Figure D)			

1. Per ASTM B 912
2. Per SEMI F19, HP grade
3. 28" Hg = 50 mm Hg absolute